

DOOR MANUAL

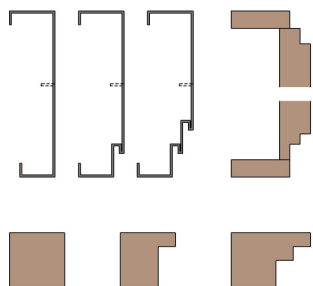

DOOR FEATURES OVERVIEW



FRAME
REBATES

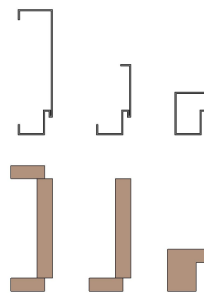

FRAME
TYPES

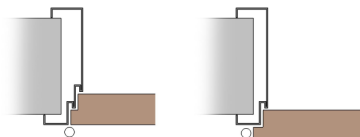

DOOR FLUSH

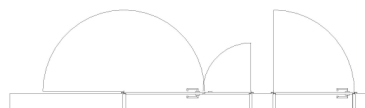

SYMBOL LINES

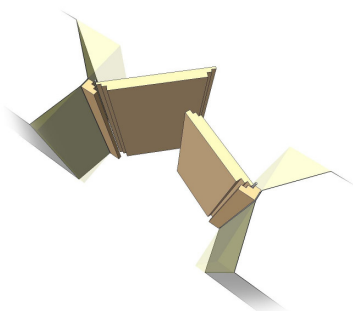

WOOD FRAME

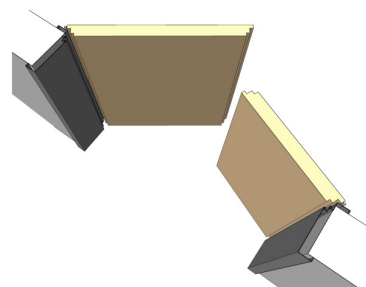

METAL FRAME

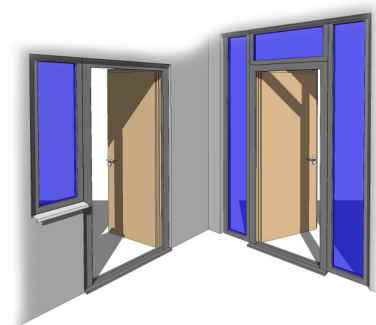

SIDE LIGHTS &
TRANSOM

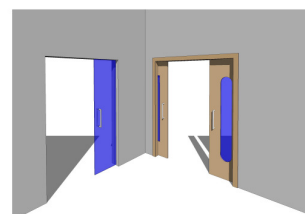

PANEL GLAZING

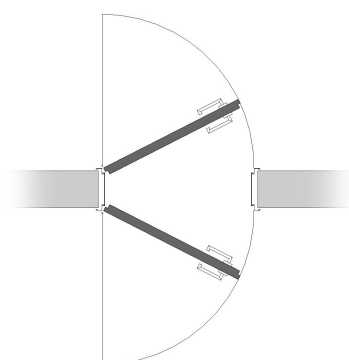

DOUBLE PANEL

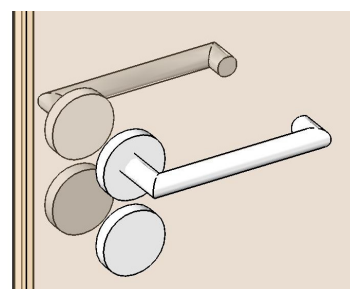

DOOR ACCESSORIES

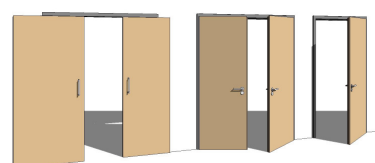

DOOR TYPES

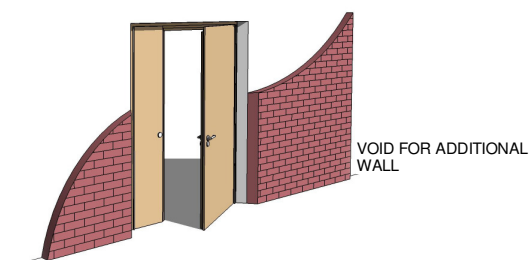

VOID FOR ADDITIONAL
WALL

DIMENSIONS OVERVIEW

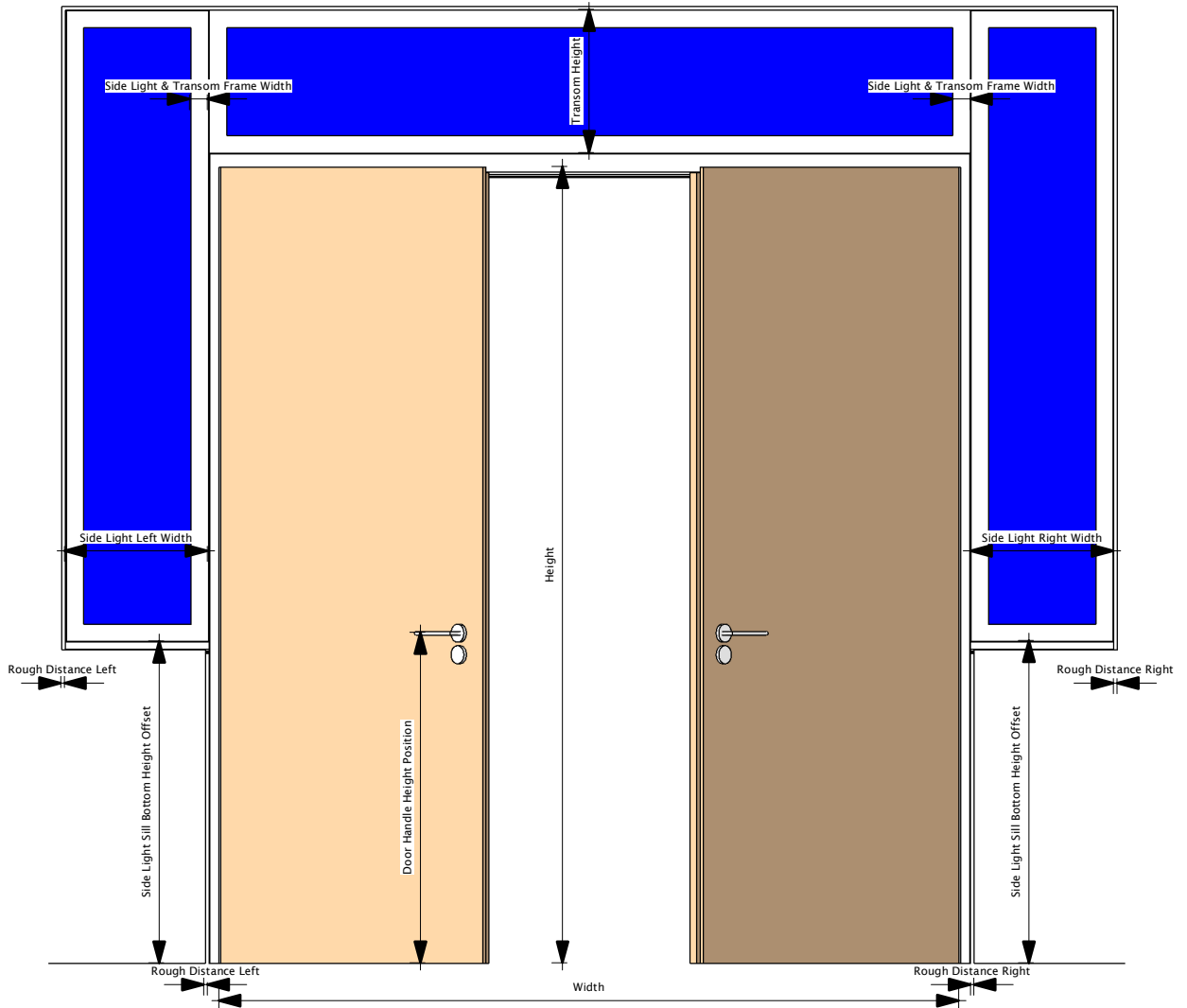
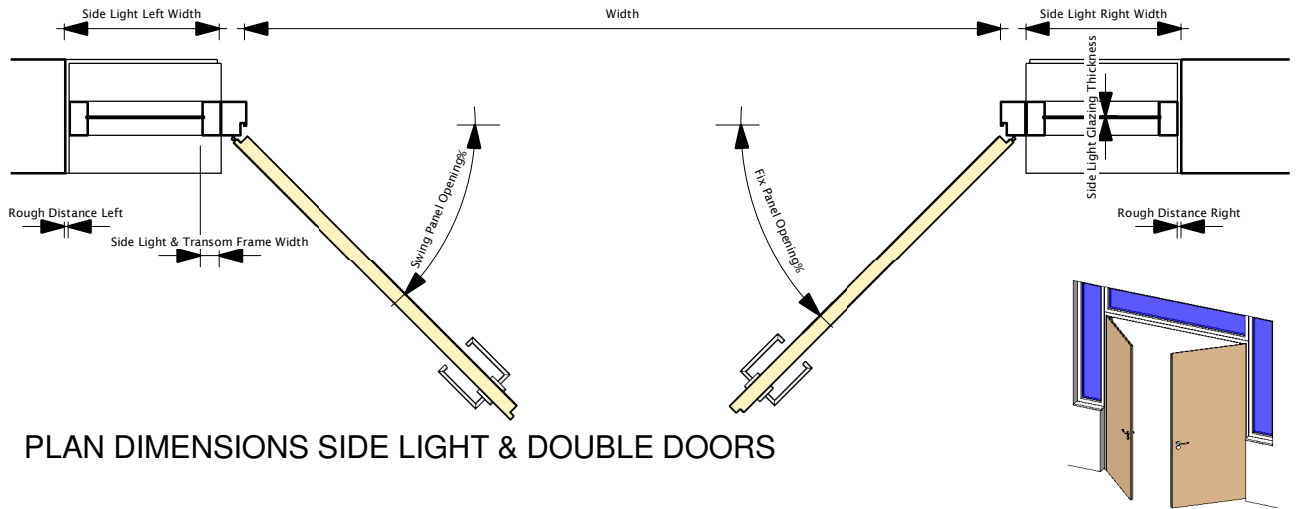

DIMENSIONS OVERVIEW

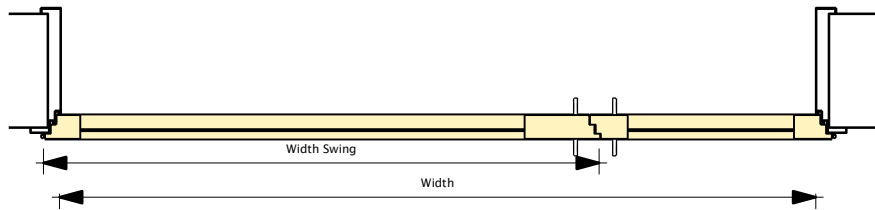

PLAN DIMENSIONS DOUBLE DOORS

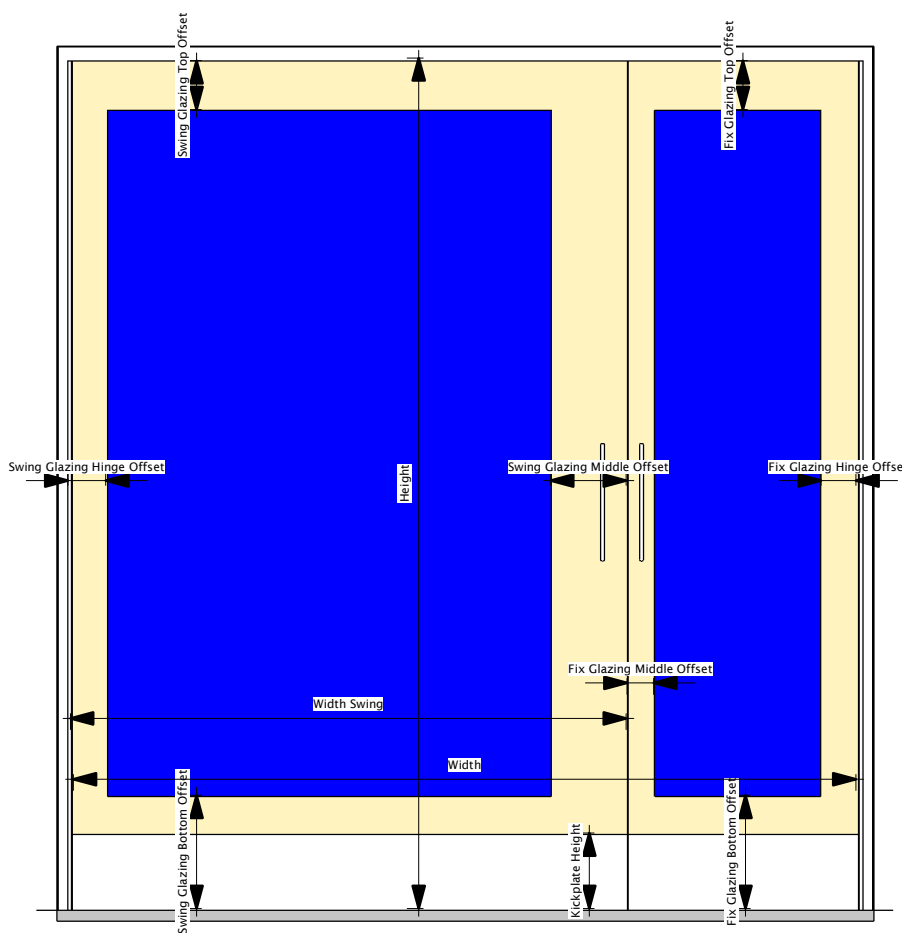
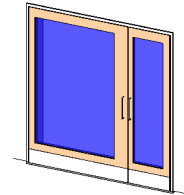

ELEVATION DIMENSIONS DOUBLE DOORS & GLAZING OPENING

DIMENSIONS OVERVIEW

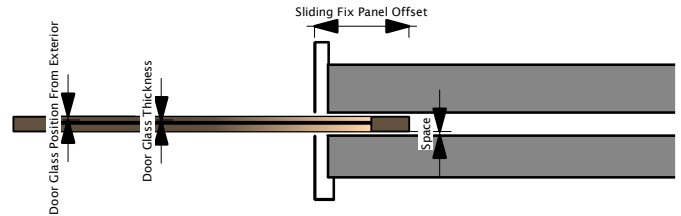
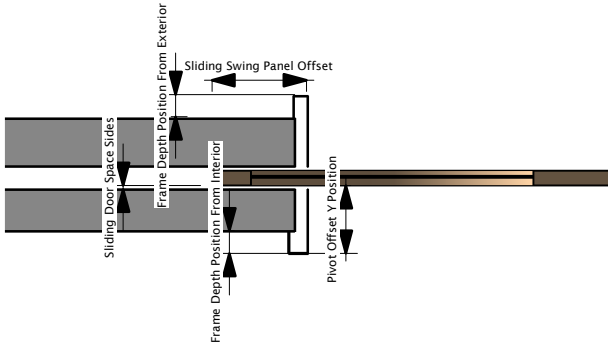

PLAN DIMENSIONS SLIDING DOORS

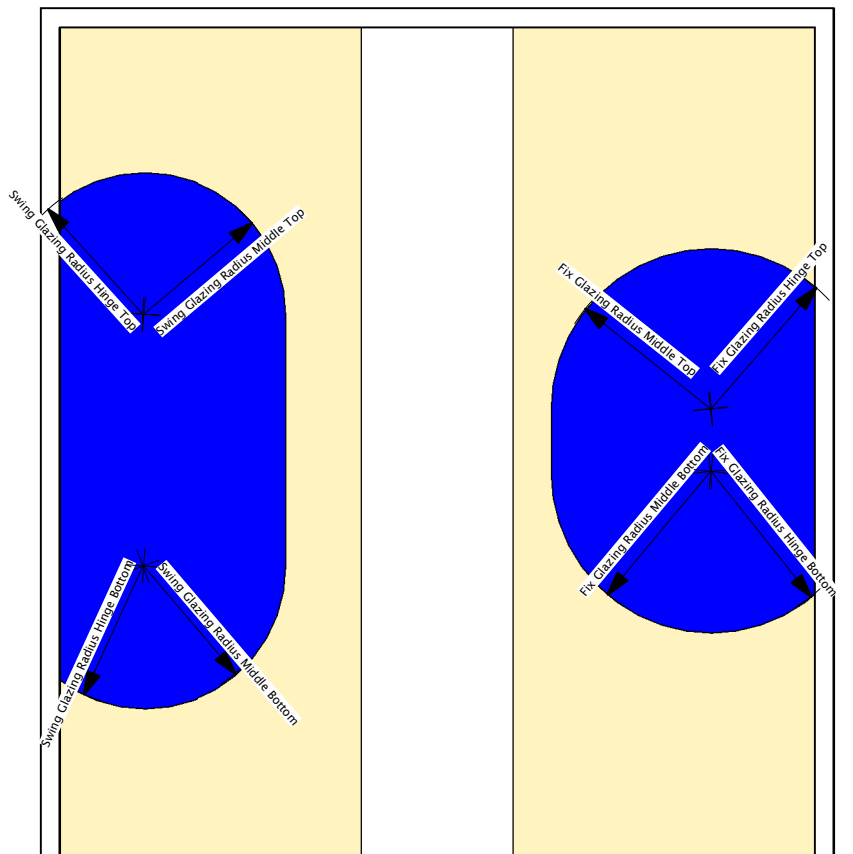
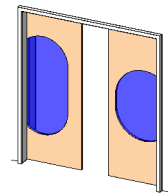

ELEVATION DIMENSIONS SLIDING DOORS & OPENING

DIMENSIONS OVERVIEW



PLAN DIMENSIONS TAPERED REVEALS

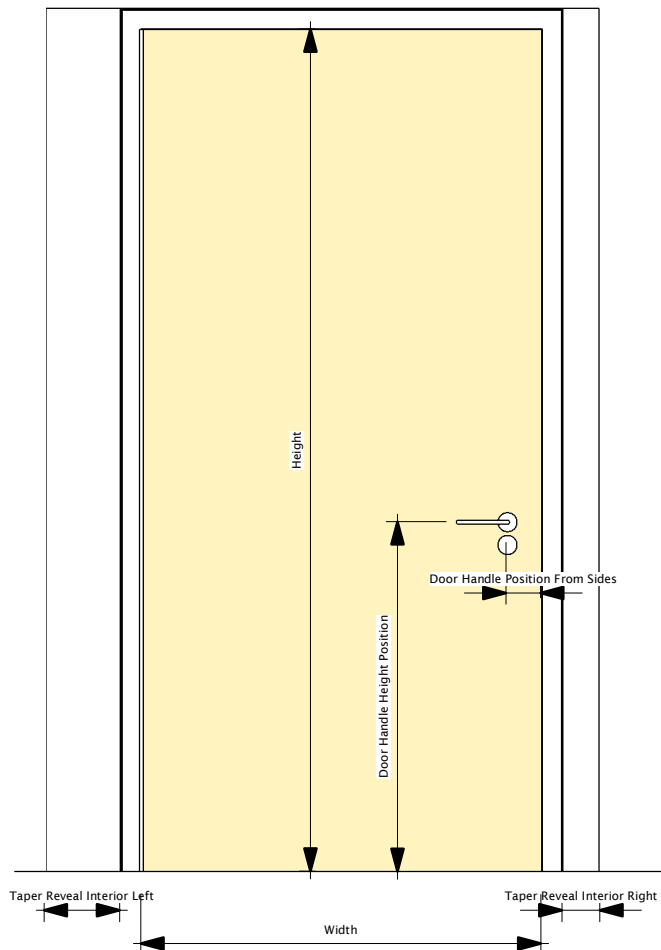
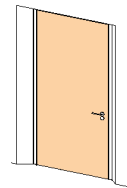

ELEVATION DIMENSIONS TAPERED REVEALS

DIMENSIONS OVERVIEW

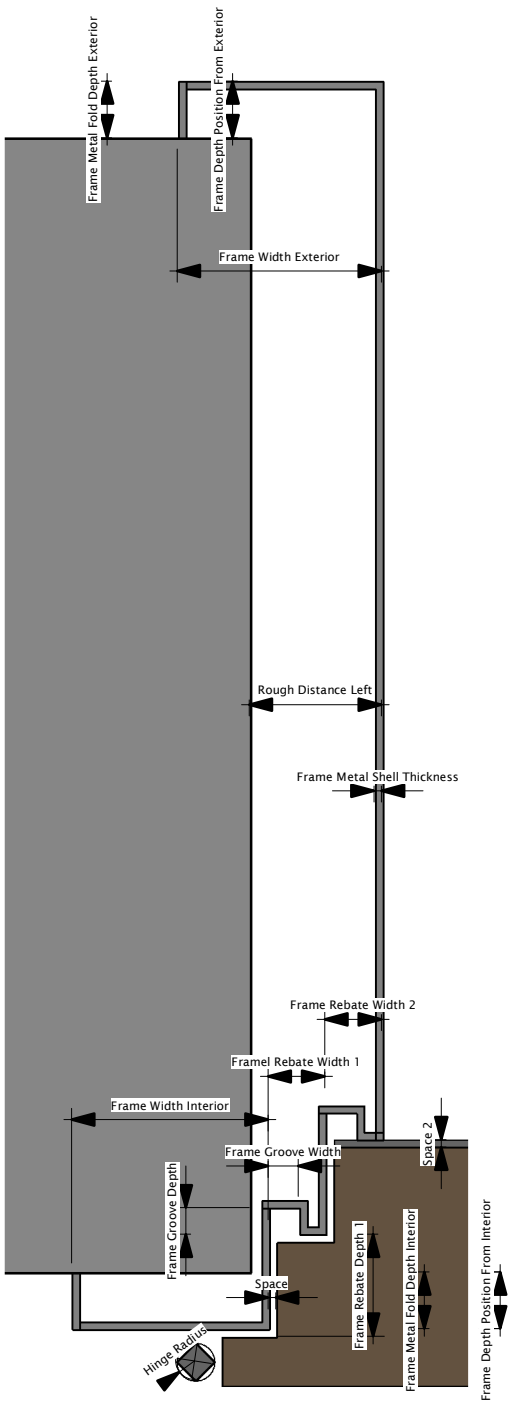

PLAN DETAIL OF METAL FRAME TYPE 1

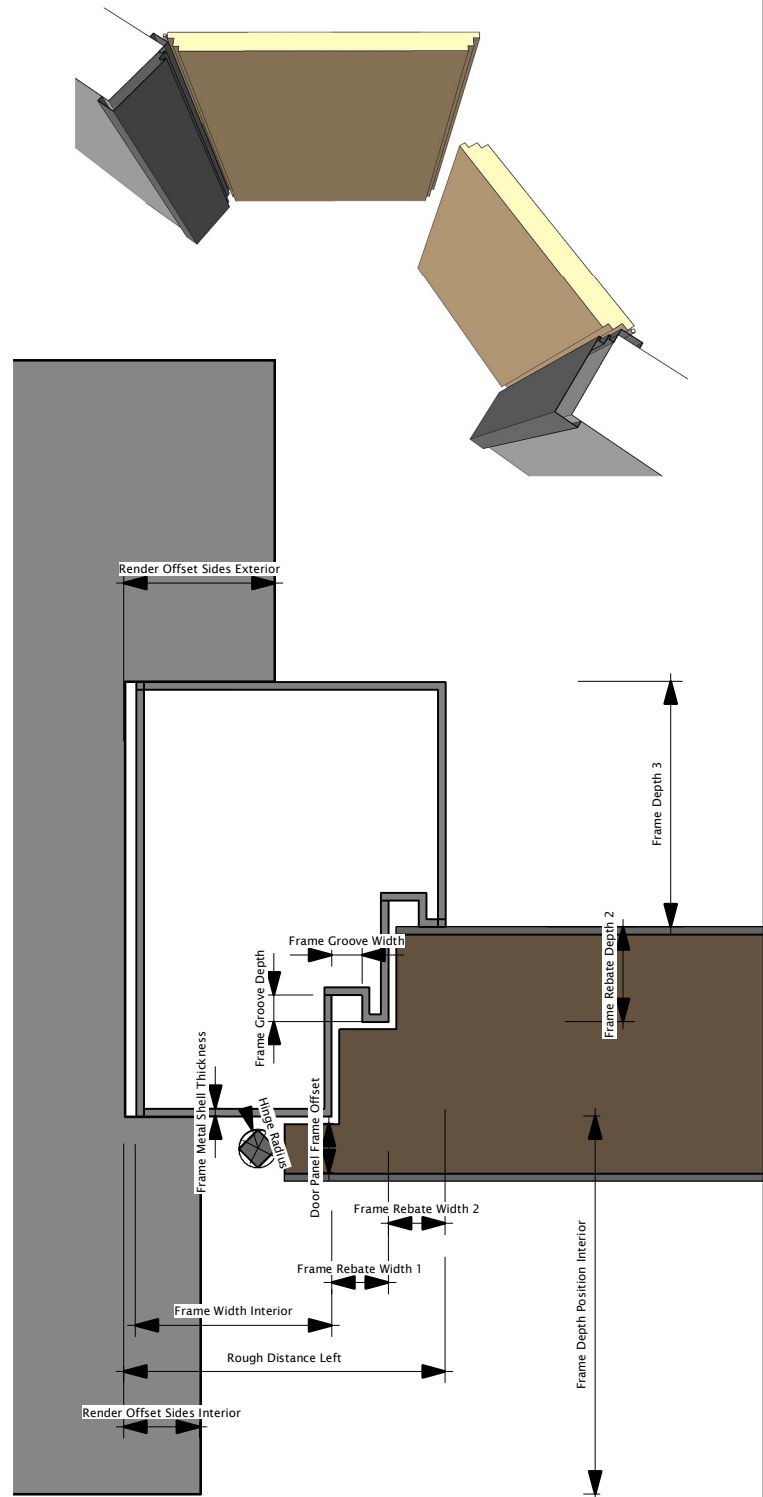

PLAN DETAIL OF METAL FRAME TYPE 3

DIMENSIONS OVERVIEW

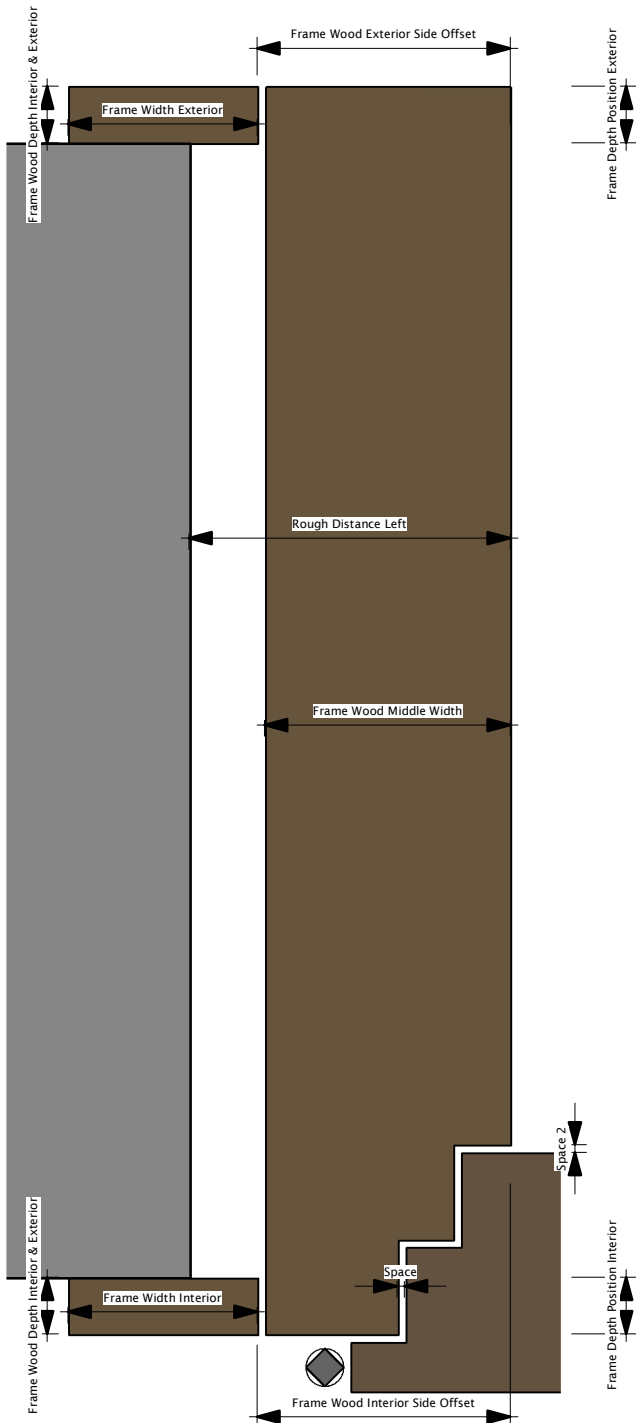

PLAN DETAIL Of WOOD FRAME TYPE 1

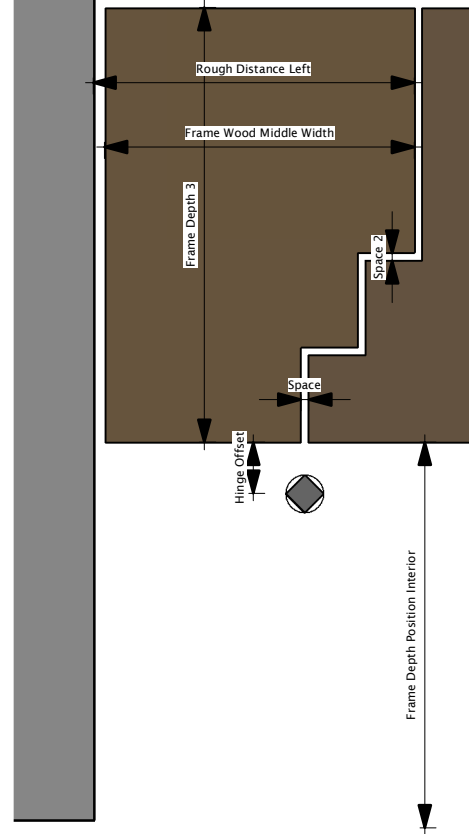
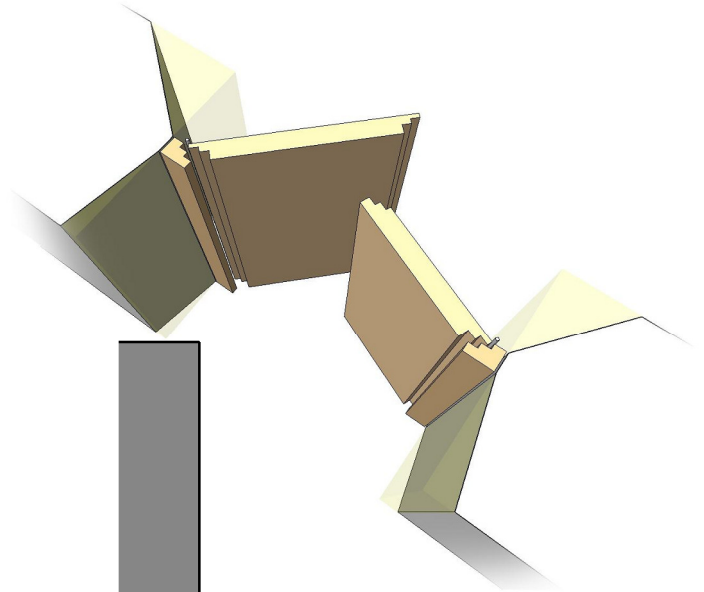

PLAN DETAIL Of WOOD FRAME TYPE 3

DIMENSIONS OVERVIEW

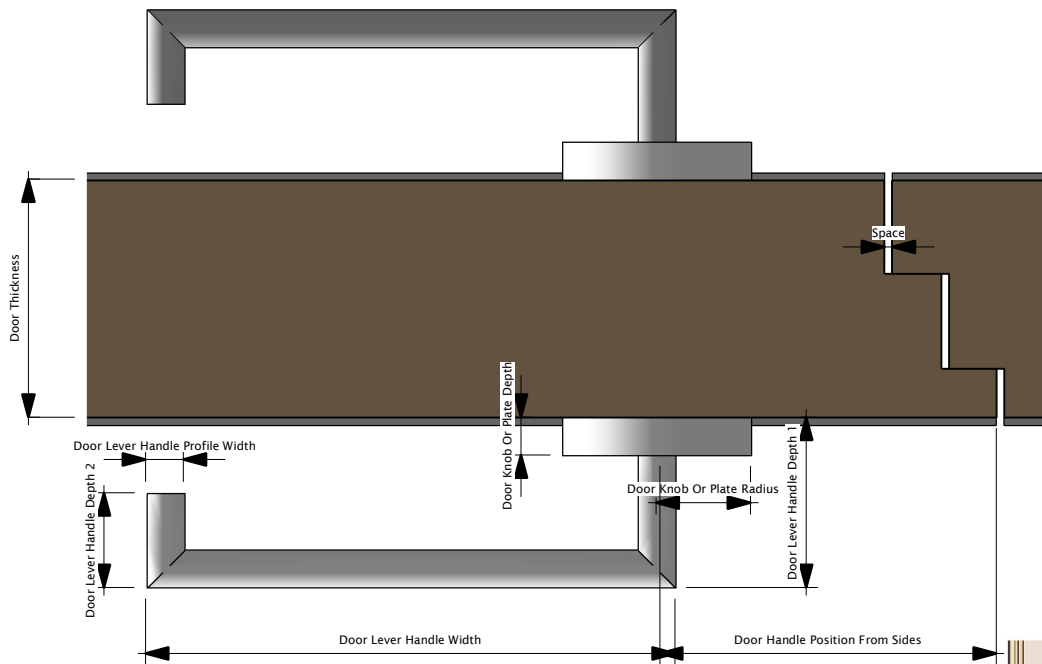

PLAN DETAIL OF HANDLE

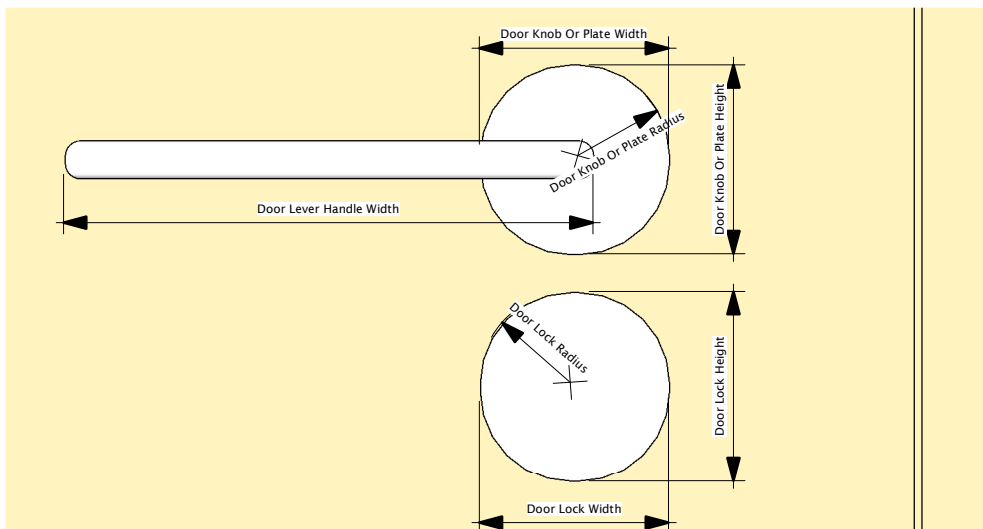
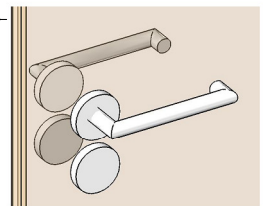

ELEVATION DOOR ACCESSORIES

SECTION OVERVIEW

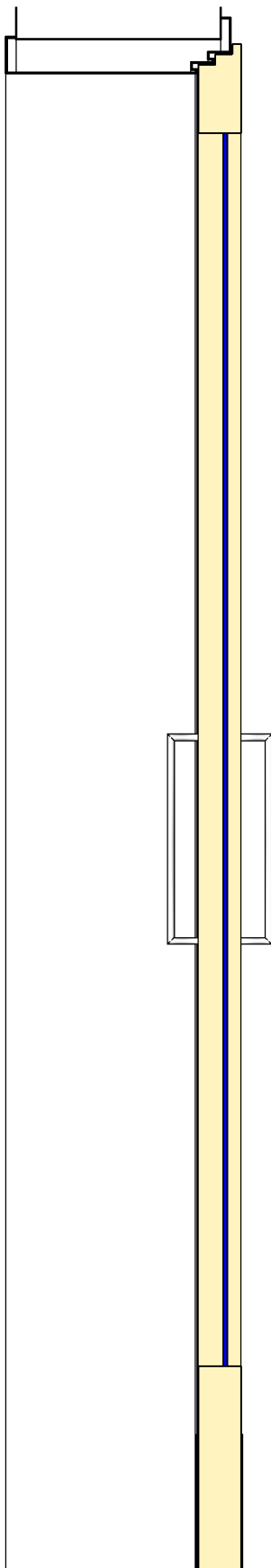

Frame Type 1
Section 1 Closure Frame

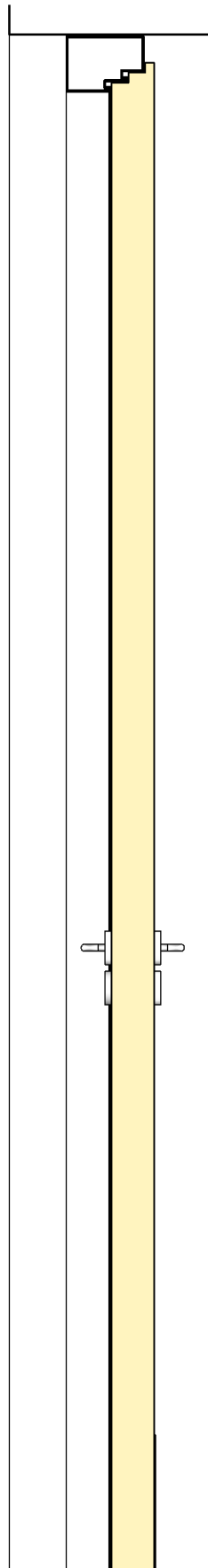

Frame Type 2
Section 2 Block Frame

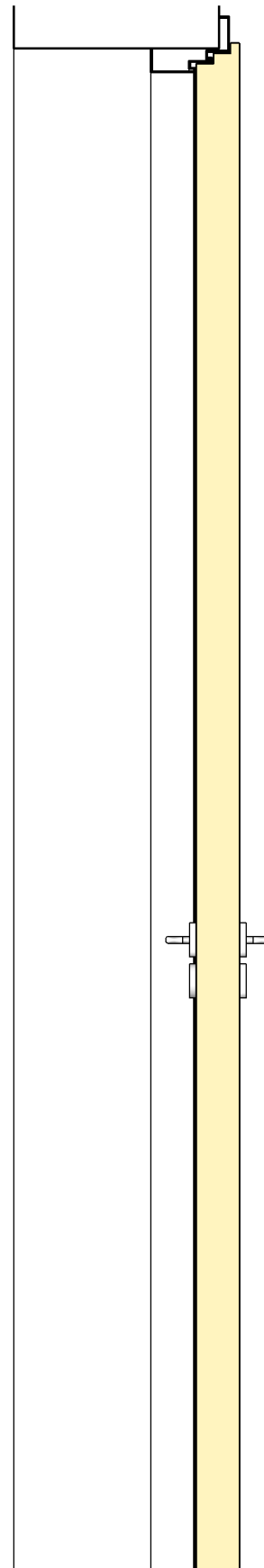

Frame Type 3
Section 3 Corner Frame

FIG 1

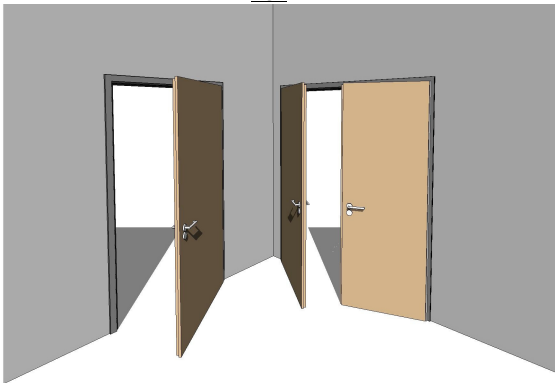

FIG 2

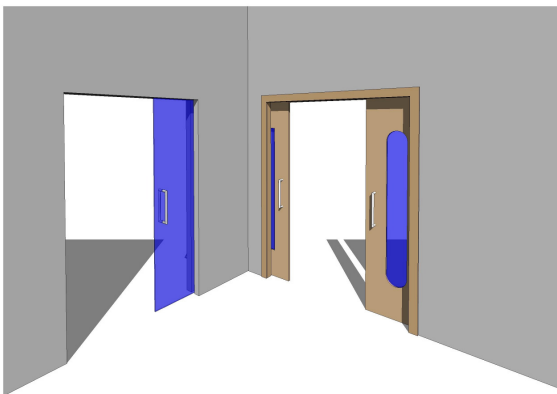

FIG 3



How To Create Double & Single Doors

In the Type Parameters under:-

Graphics

The tick box that needs to be selected is:-
DOUBLE DOOR

If the Tick Box **DOUBLE DOOR** is selected,
The Result is shown as a Double Swing Door as shown in **Fig 1**
If unselected, The Result is shown as a Single Swing Door as shown in **Fig 1**

Dimensions

You can specify and control the panel width with the Parameters **WIDTH SWING**.
This parameter lets you control the width of the Left panel when **DOUBLE DOOR** is selected,
When the width of the left panel is adjusted the right panel changes its width accordingly.
You can adjust the **WIDTH SWING** so that you have a result of the left panel to have an equal or greater width to the right panel.

Please Note when adjusting the **WIDTH** of the panel when double doors, the **WIDTH SWING** has to be adjusted accordingly as the value you put in for this parameter stays fix and the right panel adjusts to the remaining width of the clear **WIDTH** opening. The **WIDTH SWING** value needs to be more than 300mm.

The single door is adjusted by the parameter **WIDTH** and adjusts automatically to the width of the opening and the right door disappears

If **DOUBLE DOOR** is unselected which results in a single swing panel than the parameter **WIDTH SWING** does not need to be adjusted.

(PLEASE REFER TO DIMENSIONS OVERVIEW)

How To Create Single & Double Sliding Doors

In the Type Parameters under:-

Graphics

The tick box that needs to be selected is:-
SLIDING DOOR

If the Tick Box **SLIDING DOOR & DOUBLE DOOR** is selected the Result is shown as a Double Sliding Door as shown in **Fig 2**
If **DOUBLE DOOR** unselected, the result is shown as a Single Sliding Door as shown in **Fig 2**

Dimensions

The Additional parameters that you can control for the sliding doors are:-
SLIDING SWING PANEL OFFSET & SLIDING FIX PANEL OFFSET

These parameters let you control the amount of offset you require for the door to be within the cavity left & right. If the parameter is adjusted to zero, the door will be the same size as the opening width. If you adjust this parameter to 50mm, the door will have an offset of 50mm in to the cavity.

SPACE

This parameter lets you control the space between the Door Panel and the Cavity. Adjusting this parameter to zero will result with no space, if adjusted to 5mm there will be a space of 5mm between the panel and the cavity.

PIVOT Y POSTION

This parameter lets you control the position of the door from the interior.
You can create a door which is either on the internal surface of the wall just by adjusting this parameter to zero or have an offset to have the sliding doors center of the wall.
Please refer to page 4 of 15 **Plan View** By adjusting the parameter **FRAME DEPTH POSITION FROM INTERIOR** you can create the position of the sliding door to flush with the interior of the wall or have the position on the external surface of the wall.

Please note that the parameter **WIDTH SWING** adjust when Sliding Door & Double Door is activated

(PLEASE REFER TO DIMENSIONS OVERVIEW)

How To Create Transom Window & Side Lights

In the Type Parameters under:-

Graphics

The tick boxes that need to be selected are:-
SIDE LIGHT LEFT VISIBILITY, SIDE LIGHT RIGHT VISIBILITY & TRANSOM WINDOW VISIBILITY

If the Tick Box **SIDE LIGHT LEFT VISIBILITY, SIDE LIGHT RIGHT VISIBILITY & TRANSOM WINDOW VISIBILITY** are selected,
The Result is shown as **Fig 3**
If unselected, The Result is shown without any Sidelight or Transom.

Dimensions

The Additional parameters that you can control for the Side Lights and Transom Window are:-
SIDE LIGHT & TRANSOM INTEGRATED

If selected, this Parameter allows you to have a Side Light which has a separate frame from the door to a integrated frame to the door.

SIDE LIGHT SILL VISIBILITY

This parameter lets you control the visibility of the internal & external sill.
The parameters for these sills are explained below

SIDE LIGHT SILL BOTTOM HEIGHT OFFSET

This parameter lets you control the height of the Side Light Sills

SIDE LIGHT & TRANSOM FRAME WIDTH

SIDE LIGHT LEFT WIDTH, SIDE LIGHT RIGHT WIDTH & TRANSOM HEIGHT

SIDE LIGHT EXTERNAL SILL PLATE HEIGHT

SIDE LIGHT EXTERNAL SILL DEPTH

SIDE LIGHT EXTERNAL SILL ANGLE

SIDE LIGHT INTERNAL SILL HEIGHT

SIDE LIGHT INTERNAL SILL DEPTH

(PLEASE REFER TO DIMENSIONS OVERVIEW)

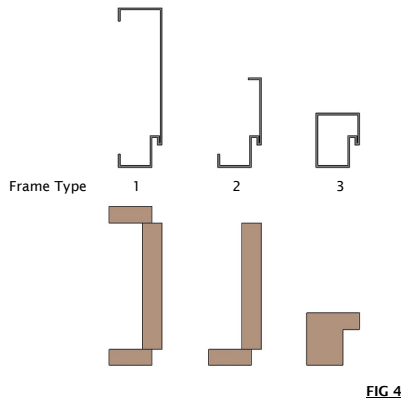

FIG 4

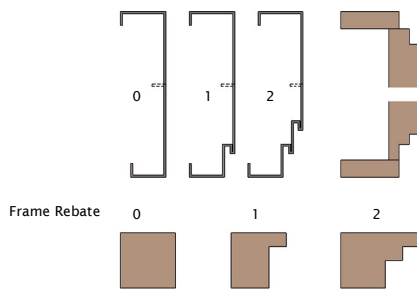

FIG 5

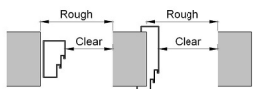

FIG 6

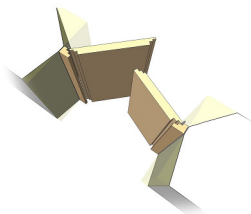

FIG 7

FIG 8

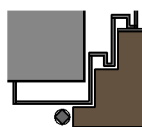
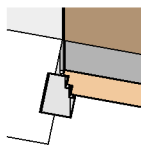
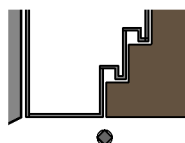

FIG 9

FIG 10



How To Create Frame Types & Frame Rebates

In the Type Parameters under:-

Constraints

To change the Frame Type or Frame Rebate the parameters are:-
FRAME TYPE & FRAME REBATE

The *FRAME TYPE* has 3 Types as shown in Fig 4

Frame Type 1= Closure Frame
Frame Type 2= Corner Frame
Frame Type 3= Block Frame

Frame Type 1 which is a Closure Frame, closes the depth of the wall or can be flush with the wall on the interior and exterior. The Parameter which controls the positions are:- *FRAME DEPTH POSITION INTERIOR & FRAME DEPTH POSITION EXTERIOR* Please refer to page 4 of 15 Plan View. By adjusting the parameter *FRAME DEPTH POSITION FROM INTERIOR*. You can have a negative value which results in the frame adjusting outwards, or have a zero value to have the frame flush with the walls, or have a positive value which results in the frame adjusting inwards.

Frame Type 2 which is a Corner Frame sits on the Interior corner of the wall

Frame Type 3 which is a Block Frame sits anywhere in the middle of the wall. The Parameter which controls the position of the Block Frame is *FRAME DEPTH POSITION INTERIOR*

The *FRAME REBATE* can have up to 2 Rebates as shown in Fig 5

Frame Rebate 0 = No Rebate
Frame Rebate 1 = One Rebate
Frame Rebate 2 = Two Rebates

The Frame Rebates can be used along with all frame types apart from the Sliding Doors which automatically adjust to Frame Type 1 and the Side Lights setups and Transom window automatically adjust to Frame Type 3.

These Frame Types can be adjusted to either Wood Frame or Metal with a click of a button enabling *WOOD FRAME*

All parameters for frame types, frame rebates and positioning have the same parameters for both Wood frame & Metal frames

(PLEASE REFER TO DIMENSIONS OVERVIEW)

Rough Distance

In the Type Parameters under:-

Dimensions

To Have a Rough Distance from the Clear Width the parameters are:-

ROUGH DISTANCE LEFT, ROUGH DISTANCE RIGHT, ROUGH DISTANCE BOTTOM, ROUGH DISTANCE TOP, ROUGH DISTANCE BOTTOM INSTANCE
All These parameters can be adjusted separately as shown in Fig 6

Rough distance on each side is from the clear opening Width or Height as Shown in Dimensions overview page 2 of 15

This has to be manually adjusted. if you have a situation where you cannot see the frame, this is probably because the Rough Distance is set to zero. If you do not want the frame visible, there is a parameter which is called *FRAME VISIBILITY*. Unselect this tick box and adjust the Rough Distance on all sides to be 0 or a desired value

ROUGH DISTANCE BOTTOM is type related parameter for all types. *ROUGH DISTANCE BOTTOM INSTANCE* is related to one instance. Both Parameters have the same function. To extend the Bottom opening of the door for varying floor thicknesses you can adjust either parameters for one instance or all types.

(PLEASE REFER TO DIMENSIONS OVERVIEW)

How To Create Tapered Reveals & Render Offsets

In the Type Parameters under:-

Dimensions

To Have Tapered Reveals the parameters are:-

TAPER REVEAL INTERIOR LEFT, TAPER REVEAL INTERIOR RIGHT, TAPER REVEAL EXTERIOR LEFT, TAPER REVEAL EXTERIOR RIGHT, TAPER REVEAL INTERIOR TOP, TAPER REVEAL EXTERIOR TOP.

All parameters can be adjusted separately as shown in Fig 7

To Have Render Offset the parameters are:-
RENDER OFFSET SIDES INTERIOR, RENDER OFFSET SIDES EXTERIOR, RENDER OFFSET TOP INTERIOR, RENDER OFFSET TOP EXTERIOR.

as shown in Fig 8

Please note that the positioning of the frame will affect the reveals adjusting

These parameters also can be used on a joined wall Please refer to page 13 of 15 Fig 12 and notes

(PLEASE REFER TO DIMENSIONS OVERVIEW)

Hinges

The Hinge Position automatically disappear when Sliding Door is activated. When *DOOR FLUSH* is selected the Hinge Position is automatically adjusted to the center of the space between the door and the Frame as shown in Fig 10.

When Door Flush is deactivated the Hinge Position repositions itself to the side of the panel which offsets from the frame and center as shown in Fig 9. The panel offset can be adjusted by using the parameter *PANEL FRAME OFFSET* only when the parameter *DOOR FLUSH* is not selected. These parameters can be adjusted in any Door setup

In the Type Parameters under:-

Dimensions

To Adjust Hinges the parameters are:-
HINGE RADIUS, HINGE OFFSET

(PLEASE REFER TO DIMENSIONS OVERVIEW)

Door Flush & not Flush

Graphics

When *DOOR FLUSH* is Selected as shown in Fig 10

When *DOOR FLUSH* is Deselected as shown in Fig 9

(PLEASE REFER TO DIMENSIONS OVERVIEW)

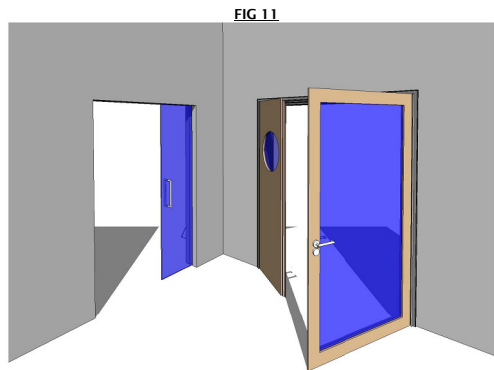

How To Create Panel Glazing

In the Type Parameters under:-

Graphics

To Create Panel Glazing, The parameters are:-
PANEL GLAZING VISIBILITY LEFT , *PANEL GLAZING VISIBILITY RIGHT*
When both Parameters are selected the result is shown as Fig 11

Dimensions

Each door has its own parameters to adjust the Panel Glazing frame thickness and the radius for each corner of the panel frame
The Parameters for the Left Door are:-

SWING GLAZING TOP OFFSET
SWING GLAZING MIDDLE OFFSET
SWING GLAZING HINGE OFFSET
SWING GLAZING BOTTOM OFFSET

SWING GLAZING RADIUS MIDDLE TOP
SWING GLAZING RADIUS MIDDLE BOTTOM
SWING GLAZING RADIUS HINGE TOP
SWING GLAZING RADIUS HINGE BOTTOM

The Parameters for the Right Door are:-

FIX GLAZING TOP OFFSET
FIX GLAZING MIDDLE OFFSET
FIX GLAZING HINGE OFFSET
FIX GLAZING BOTTOM OFFSET

FIX GLAZING RADIUS MIDDLE TOP
FIX GLAZING RADIUS MIDDLE BOTTOM
FIX GLAZING RADIUS HINGE TOP
FIX GLAZING RADIUS HINGE BOTTOM

(PLEASE REFER TO DIMENSIONS OVERVIEW)

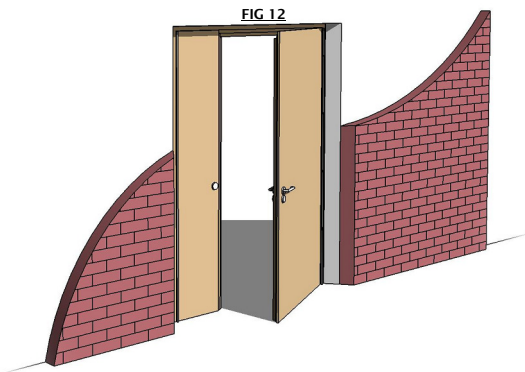

Void For Additional Walls

In the Type Parameters under:-

Dimensions

If you need to add an additional Wall (e.g. Dry-Lining) to join with the original wall. Create a new basic wall, change the properties as your specification and join the to original wall.
To cut the new additional wall that has been added either to the interior or exterior of the original wall, adjust the parameters:-

VOID INTERIOR OFFSET or *VOID EXTERIOR OFFSET* to the thickness of the additional new wall added, the result will be a cut out of the new wall as shown in Fig 12

Please note that all parameters for tapered reveals and render offset can apply to new additional walls when the void is offsetted

(PLEASE REFER TO DIMENSIONS OVERVIEW)

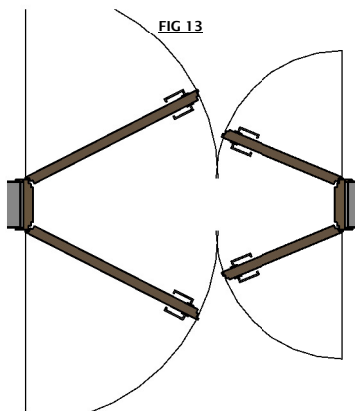

How To Create Double Panel

In the Type Parameters under:-

Graphics

You can setup a Double Panel Door for the Single and Double Swing Door as you might need for Hotel or Office Project where noise reduction is a subject. To Create Double Panel, The parameters are:-

DOUBLE PANEL VISIBILITY as shown as Fig 13

(PLEASE REFER TO DIMENSIONS OVERVIEW)

How To Create Symbol Lines

In the Type Parameters under:-

Constraints

To Create Symbol Lines select the parameters in the instance properties box *SYMBOL LINES* the result will be Fig 14 & 15

All Symbol Lines will appear in Plan & Elevations

To have symbol lines adjusted to your local standards, showing the opposite side in elevation, adjust the parameter *SYMBOL LINES FROM HINGE SIDE* the result will show the symbol lines flipped only in elevation on the opposite side as shown in Fig 15

To Have Symbol Lines adjusting in plan view, select the parameter *SYMBOL LINES OPENING ANGLE SYNC*.

The symbol lines will adjust with the Parameters:-
DOOR OPENING LEFT & SINGLE and *DOOR OPENING RIGHT*

If the parameter *SYMBOL LINES OPENING ANGLE SYNC* is unselected, the symbol lines will not adjust with the parameters

DOOR OPENING LEFT & SINGLE and *DOOR OPENING RIGHT*.

They can be manually adjusted with the parameters under the Dimensions called *SYMBOL LINES OPENING ANGLE RIGHT & SYMBOL LINES OPENING ANGLE LEFT*.

The Symbol lines will remain static at the position you require once adjusting, while you adjust the doors to a close position or a angle that you specify as shown in Fig 13

Please note that these symbol lines are shown in Coarse, Medium & Fine Modes and are ideally used in plan view with or without the Doors Visibility.

To switch off the Doors Visibility , under Graphics unselect the parameter *DOORS VISIBILITY*.

All doors for that type will be switched of and you will remain with the symbol lines showing.

To switch of the symbol lines simply unselect the *SYMBOL LINES* parameter under Graphics, all Symbol lines will turn off.

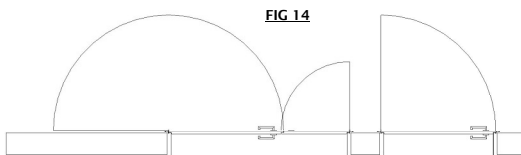
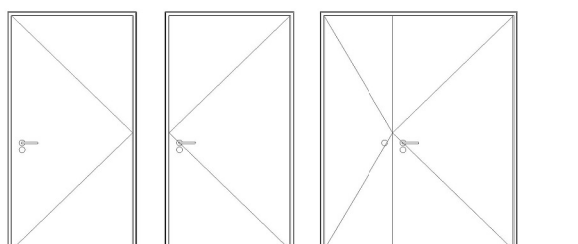
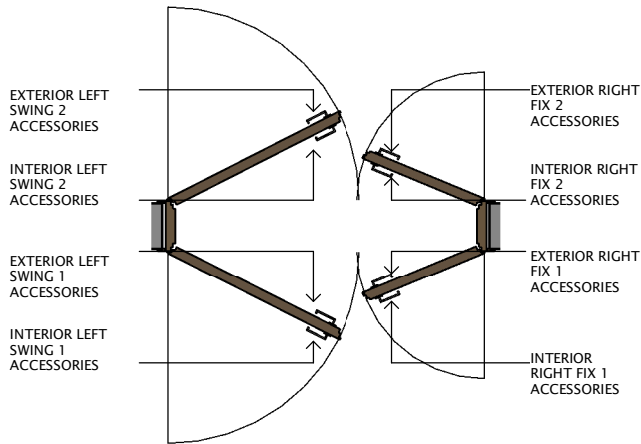

FIG 15



Door Accessories



In the Type Parameters under:-

Dimensions

All The accessories have Dimensions and are stated as below

Door Knob Handle

Door Knob Or Plate Handle Height
Door Knob Or Plate Handle Width
Door Knob Or Plate Handle Depth
Door Knob Or Plate Handle Radius
Door Knob Or Plate Handle Height Position

Door Lever Handle

Door Lever Handle Width
Door Lever Handle Depth
Door Lever Handle Depth 2
Door Lever Handle Profile Radius
Door Lever Handle Profile Width
Door Lever Handle Angle

Door Lock

Door Lock Height
Door Lock Width
Door Lock Depth
Door Lock Radius
Door Lock Height Position

Door Handle Height Position
Door Handle Position From Sides

(PLEASE REFER TO DIMENSIONS OVERVIEW)

In the Instance Parameters under:-

Constraints

INTERIOR LEFT SWING 1 ACCESSORIES, INTERIOR LEFT SWING 2 ACCESSORIES, INTERIOR RIGHT FIX 1 ACCESSORIES, INTERIOR RIGHT FIX 2 ACCESSORIES
EXTERIOR LEFT SWING 1 ACCESSORIES, EXTERIOR LEFT SWING 2 ACCESSORIES, EXTERIOR RIGHT FIX 1 ACCESSORIES, EXTERIOR RIGHT FIX 2 ACCESSORIES

Each Integer parameter has the same visibility configuration on each sides of the door panels. When adjusting the integer parameter from 0 - 10 the results are the following:-

(PLEASE REFER TO DIMENSIONS OVERVIEW)



FIG 16

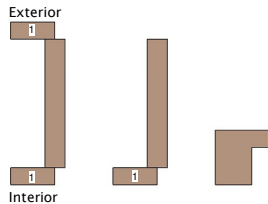
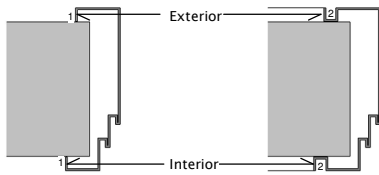

FIG 17

FIG 18

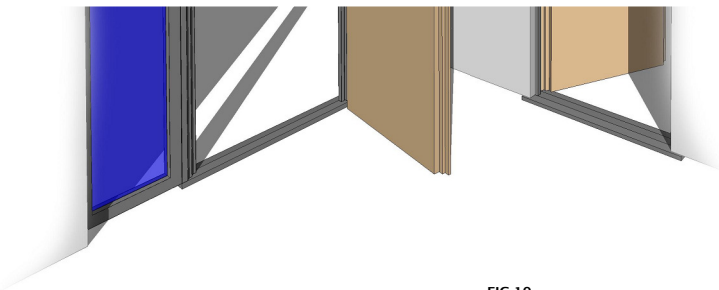

FIG 19

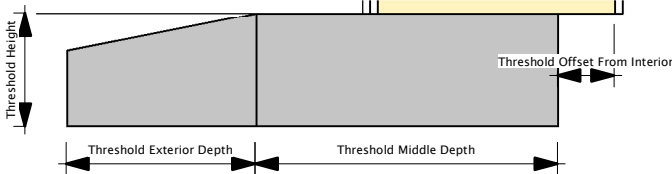

FIG 20

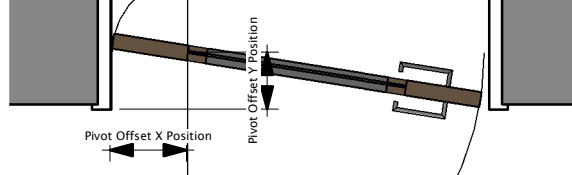
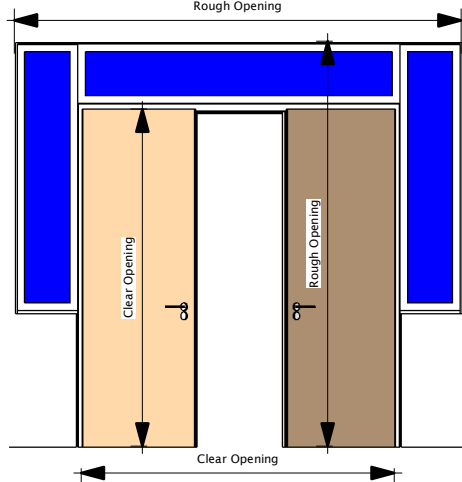

FIG 21



Frame Fold Interior & Frame Fold Exterior

In the Type Parameters under:-

Graphics

To Create Frame Folds, The parameters are:-
FRAME FOLD INTERIOR & *FRAME FOLD EXTERIOR*

Each Integer parameter has the same visibility configuration on each sides.
When adjusting the integer parameter from 0 - 2 the results are the following:-

Metal Frame as shown in Fig 16

FRAME FOLD INTERIOR
0 = No Fold
1 = Fold
2 = Shadow Gap

FRAME FOLD EXTERIOR
0 = No Fold
1 = Fold
2 = Shadow Gap

Wood Frame as shown in Fig 17

FRAME FOLD INTERIOR
0 = No Fold
1 = Interior Architrave

FRAME FOLD EXTERIOR
0 = No Fold
1 = Exterior Architrave

(PLEASE REFER TO DIMENSIONS OVERVIEW)

Threshold

In the Type Parameters under:-

Graphics

To Adjust a Threshold, The parameter is:-
THRESHOLD

When adjusting the integer parameter from 0 - 4 the results are the following:-

THRESHOLD
0 = No Threshold
1 = Interior & Middle Thresholds
2 = Exterior & Middle Thresholds
3 = Middle Threshold
4 = Interior Middle & Exterior Thresholds

Dimensions

Threshold Middle Height Offset
Threshold Middle Depth
Threshold Exterior Depth
Threshold Interior Depth
Threshold Height

(PLEASE REFER TO DIMENSIONS OVERVIEW)

Clear Opening

In the Type Parameters under:-

Graphics

To Adjust the opening, The parameter is:-
CLEAR OPENING

If Selected The Parameter Height & Width represents the Clear Opening
If Unselected The Parameter Height & Width represents the Rough Opening

When selecting the parameter *CLEAR OPENING*, the results is:-
The Clear opening of the Height & Width of the door as shown in Fig 20 & Fig 21
When unselecting the parameter *CLEAR OPENING*
The result is Rough Opening of the Height & Width as shown in Fig 20 & Fig 21

Please note that the dimension line in plan view which has the option of showing the height as well as the width, represents the value of the height when the parameter is selected and unselected to show the result of the Clear Height & Width or the Rough Opening Height & Width

(PLEASE REFER TO DIMENSIONS OVERVIEW)

Pivot Position Offset

In the Type Parameters under:-

Dimensions

Pivot X Position
Pivot Y Position

(PLEASE REFER TO DIMENSIONS OVERVIEW)

REVISION 5

Groove Or No Groove

Our new Revised family now has the advanced option to have a Groove or No Groove as Well as Double Rebate. These options can be adjusted with selecting the parameter "GROOVE" or "DOUBLE REBATE"
The "DOUBLE REBATE" is only activated when the Metal frame is activated and Frame Type 1 is selected as shownn in FIG 22 & 23

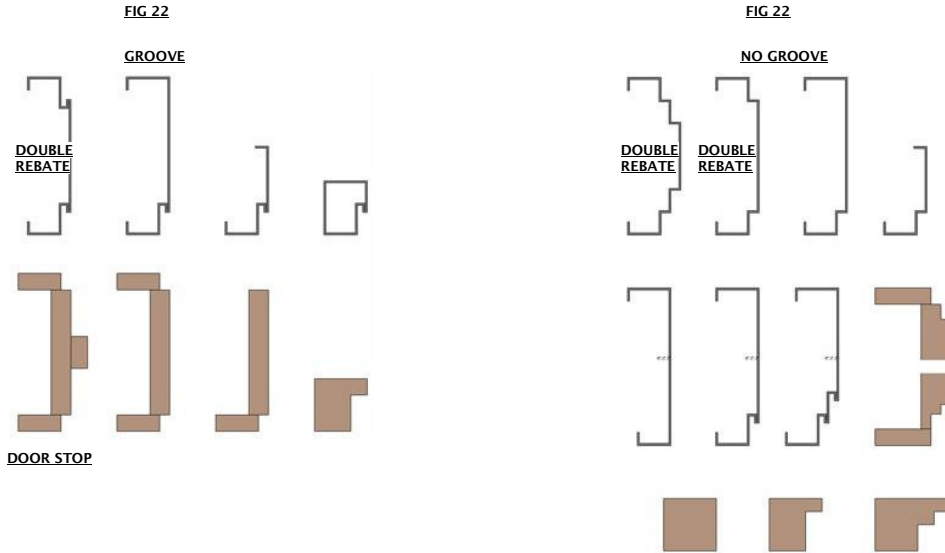

We have also included now a Door Stop for the Wood frame. This is also controlled by selecting the Parameter "DOOR STOP"
This is only activates when the Wood frame is activated and Frame Type 1 is selected as shownn in FIG 22

As well as these option we have now introduced a Metal Anchor which as shownn in FIG 23 the can be controlled by a length parameter called Metal Anchor Length. When yero the visibility will switch off

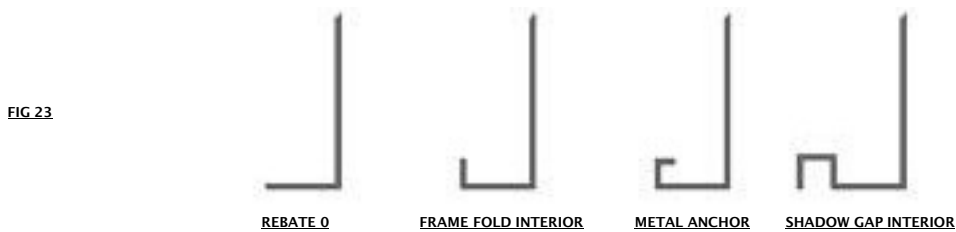

REVISION
Symbol Lines 3D

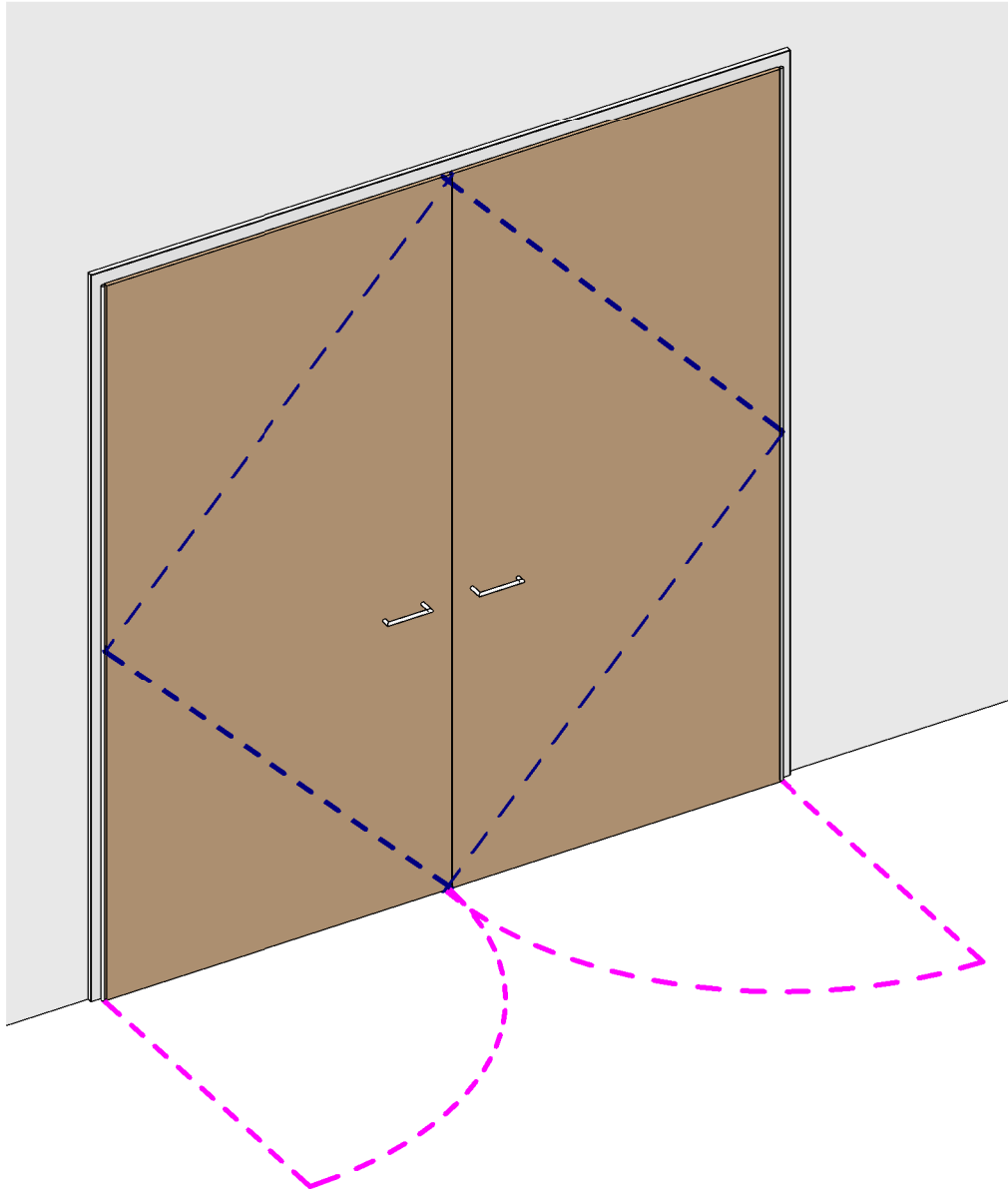

3D SYBOL LINES

Our new revised family now has the advanced option to have 3D Symbol Lines as well as 2D Symbol Lines. These options can be adjusted with selecting the parameter "2D SYMBOL LINES" or "3D SYMBOL LINES" under the Graphics Menu

The 2D SYMBOL LINES Can only be viewed in Plan & Elevation, the 3D SYMBOL LINES Show in all views

REVISION

Middle Rail

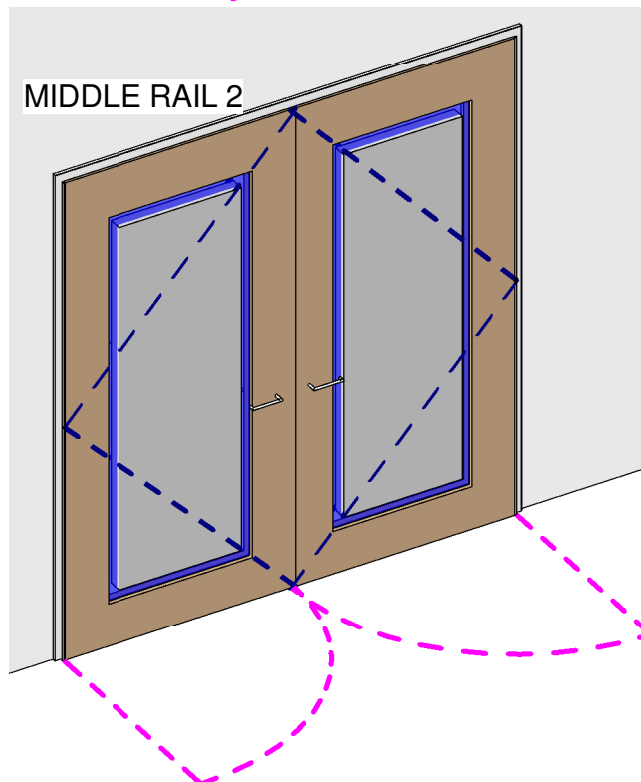
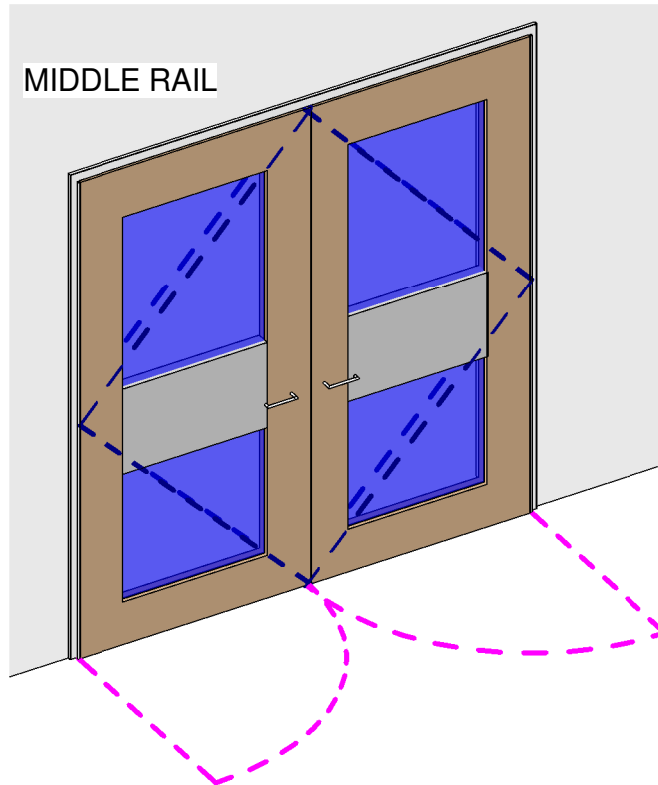

Our new revised family now has the advanced option to have a middle rail which can be setup to different configurations as shown above. These options can be adjusted with selecting the parameter "MIDDLE RAIL" under the Graphics Menu

The Middle Rail has 3 Parameters which can be adjusted to have the configuration that you need. These parameters are called: "MIDDLE RAIL HEIGHT", "MIDDLE RAIL SIDE OFFSET" & "MIDDLE RAIL HEIGHT POSITION"

Please note that the position of the Middle Rail is offsetted from the Door Panel Frame

REVISION
Swing Flip

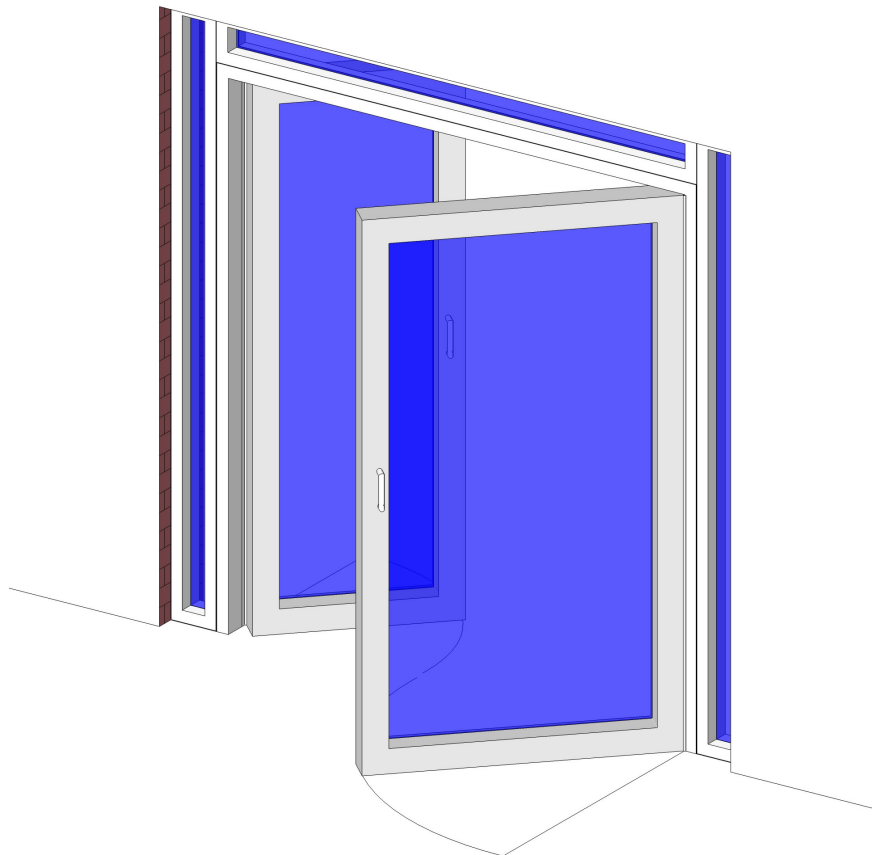
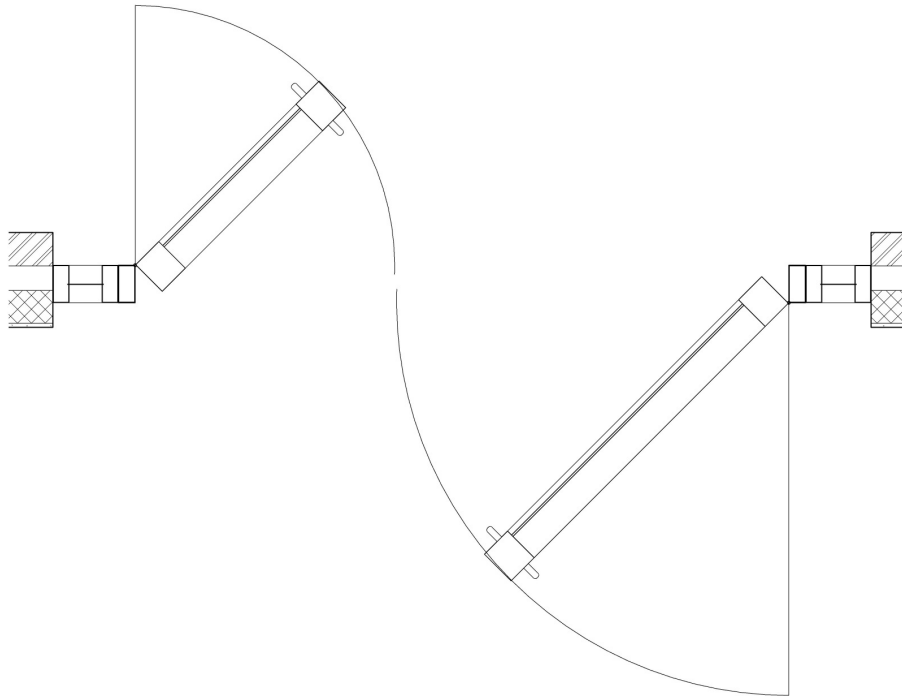

Our new revised family now has the advanced option to have Swing Flips which can be setup to different configurations as shown above so you can have the doors swinging in the opposite directions. These options can be adjusted with selecting the check box parameters "SWING PANEL FLIP" or "FIX PANEL FLIP" under the Graphics Menu. If these check box Parameters are selected the panels will flip to swing the opposite side, Please note that the Swing Flips will change the Rebates Automatically to rebate zero. If these check box Parameters are unselected the panels will swing in the normal direction showing all rebates.

REVISION

Panel Auto

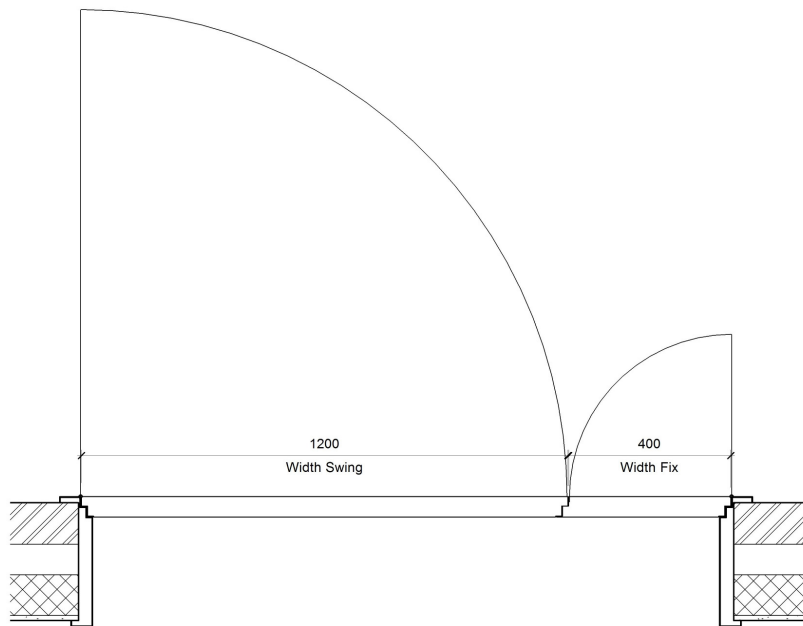
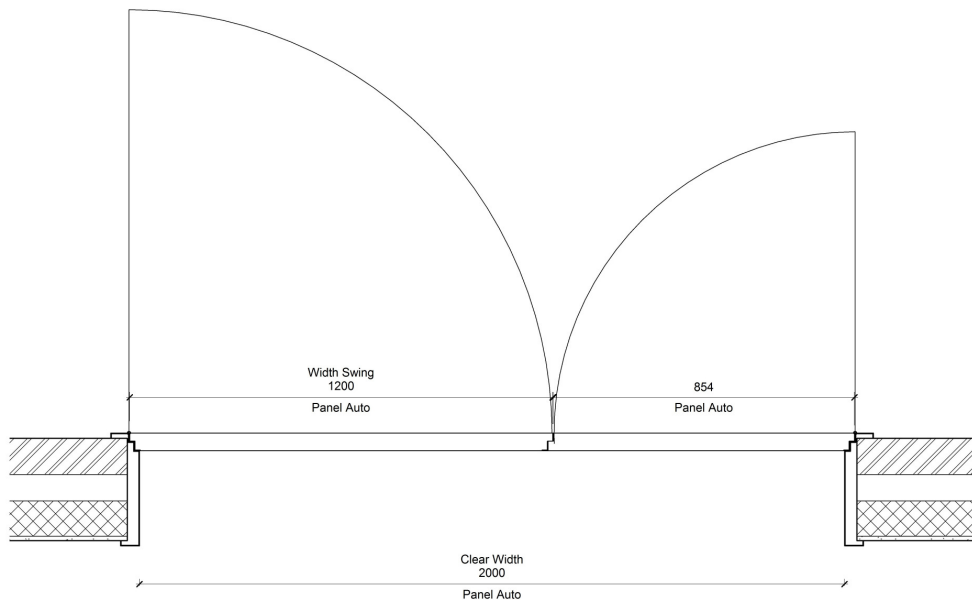

Our new revised family now has the advanced option to have The panel dimensions changed manually. This can be adjusted by selecting the parameter "Panel Dimensions Auto" under the Graphics Menu. If this check box parameter is selected, the panels will adjust automatically when the width, width swing or height parameters are adjusted. If this check box parameter is unselected, the panel dimensions can be changed manually. This will effect the clear width and height as you can adjust both the "Width Swing" & "Width Fix" parameters. Please note when the "Panel Dimensions Auto" is selected, the "Width Fix" parameter will be in active as the fix panel will adjust automatically when you change the parameters "Width" or "Width Swing".

REVISION
Glazing Bars

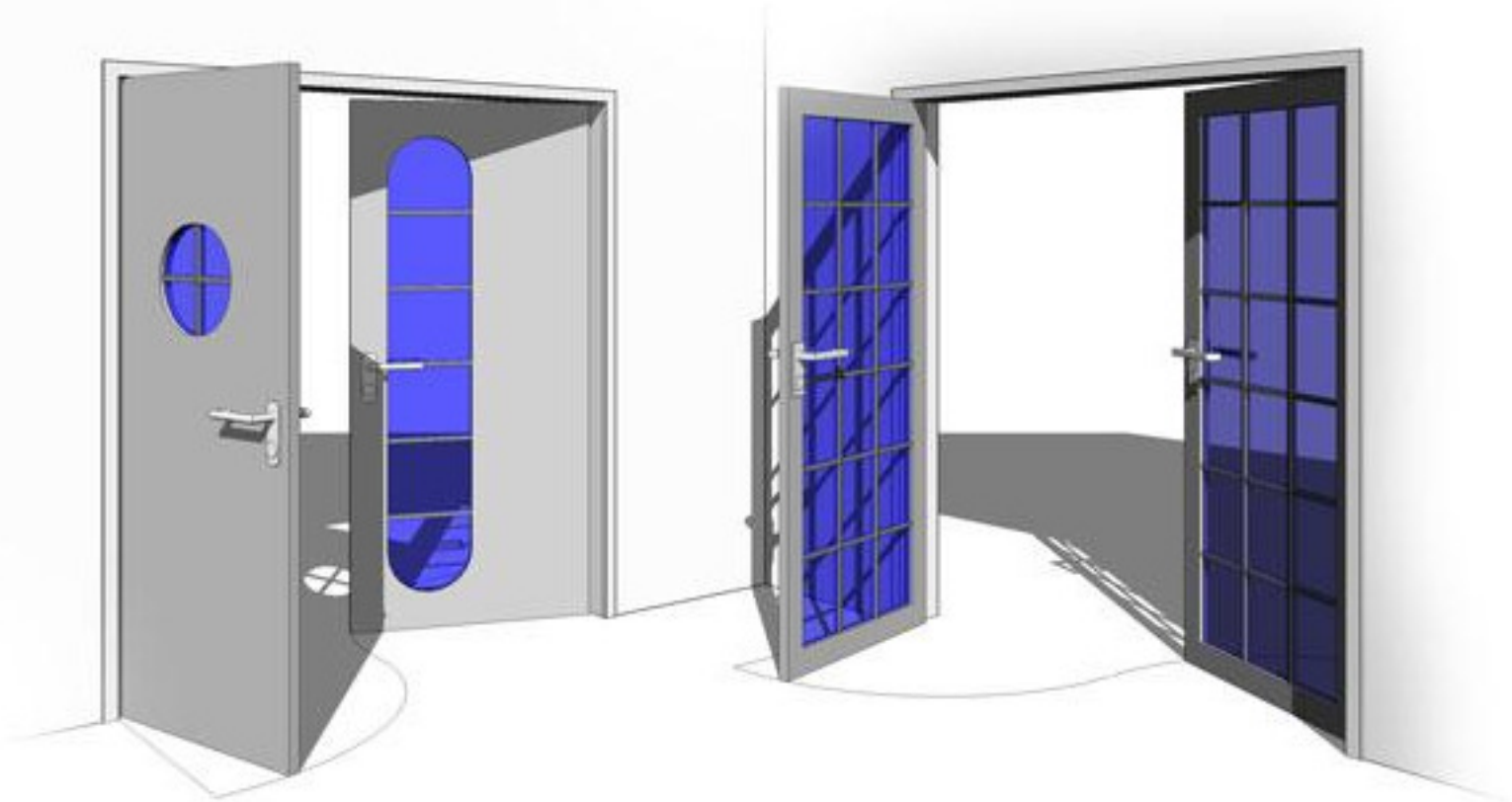

Our new revised family now has the advanced option to have Glazing Bars. These options can be adjusted with selecting the Integer parameters under the Graphics Menu which are

FIX PANEL HORIZONTAL GLAZING BAR COUNT
FIX PANEL VERTICAL GLAZING BAR COUNT
SWING PANEL HORIZONTAL GLAZING BAR COUNT
SWING PANEL VERTICAL GLAZING BAR COUNT

Each panel can be set up differently with the glazing bar count. The glazing bar width and depth can be adjusted aswell. You will find these parameters in the Dimensions menu.